

M19, FM19, M190 & FM190 Side Jamb Pivot

Handed

Installation Instructions

3/4" Offset

Door should already be hung with top pivot and bottom pivot (or floor closer)

1.  Mortise door & frame per template on reverse side.

2.  Affix pivot to door & frame.

3.  Align pivot point from top pivot to bottom arm. (See diagram)

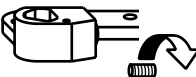
4.  Loosen arm screw*.

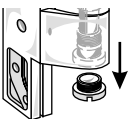
5.  Remove hex cap.

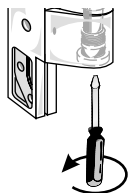
6.  Turn stud screw clockwise. Raise the door to the desired height.

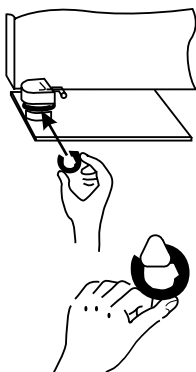
7.  Using shims furnished with bottom arm, fill gap between arm and base.

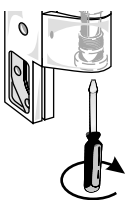
8.  Turn stud screw counterclockwise until door rests on shims.

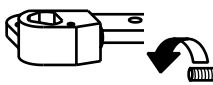
9.  Tighten arm screw on spindle. Open and close door several times. Re-tighten arm screw.

10.  Replace hex cap.

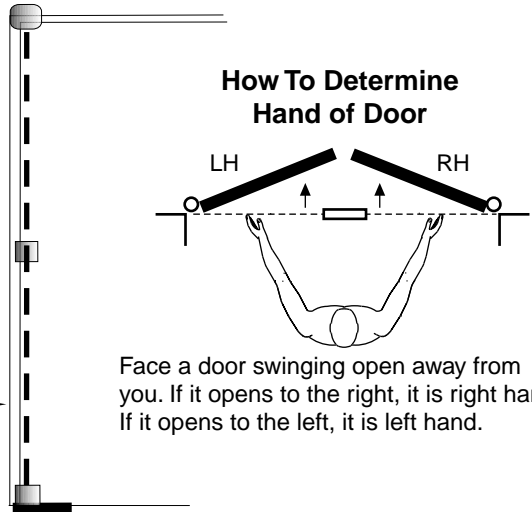

* If bottom arm is for a Uni-Chek 67/68 or 117 pivot, make sure the arm is sitting all the way down on the base. Make NO adjustments to the M19.

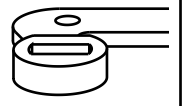

M19, FM19, M190, and FM190
Intermediate Pivot
3/4" Offset



Rixson Specialty Door Controls

www.rixson.com

NUMBER

IS-(F)M19(0)

DATE

8-06

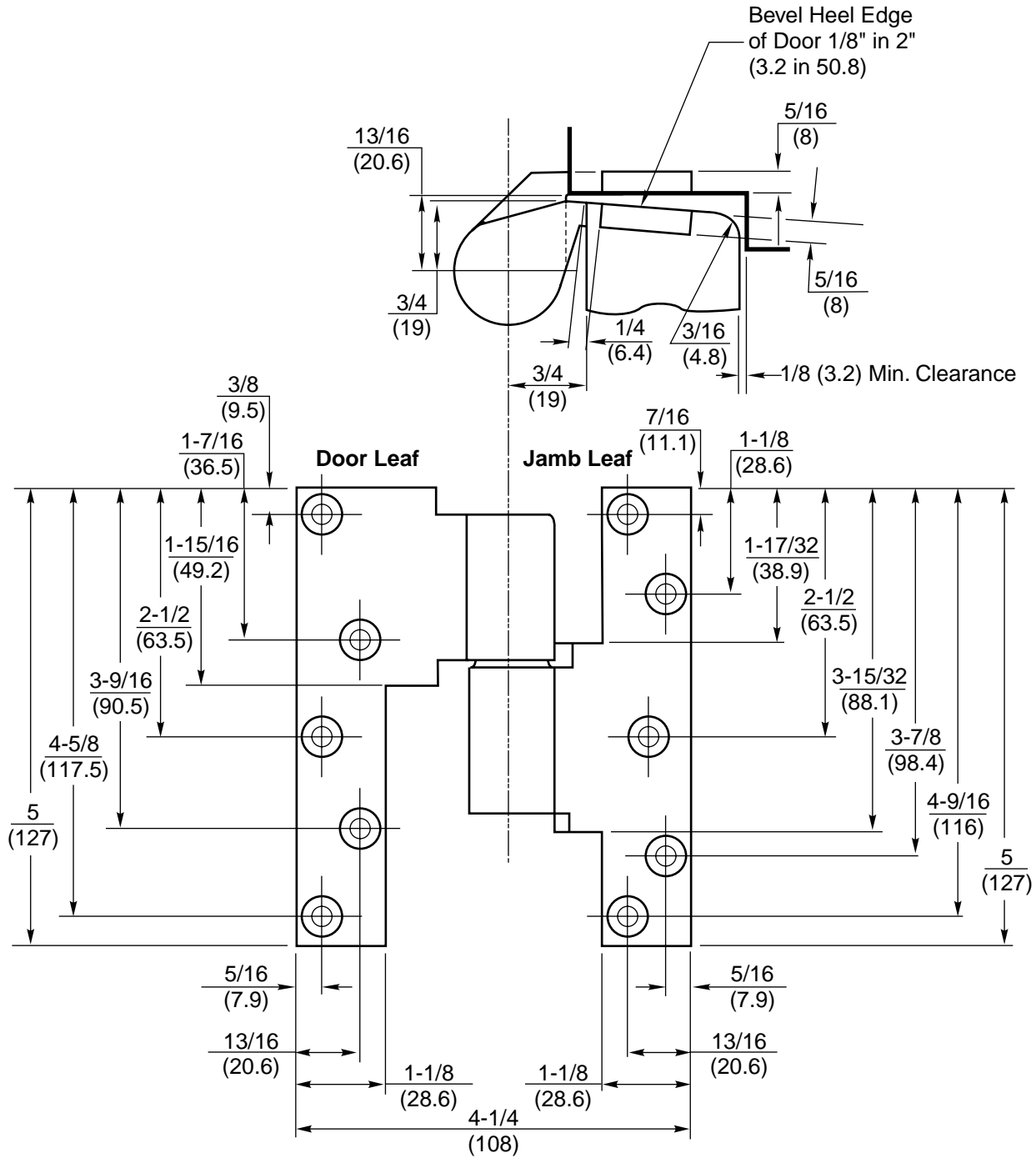

Notes:

1. Do not scale drawing.
2. Dimensions are given in inches (mm).
3. Pivot drilled for 1/4-20 x 5/8" FHMS or #14 x 1-1/2" FHWS.
4. Right hand shown.
5. Template drawing for reference only.

**M19, FM19, M190, and FM190
Intermediate Pivot
3/4" Offset**



Rixson Specialty Door Controls

www.rixson.com

NUMBER

IS-(F)M19(0)

DATE

8-06